



**Pelastuslaitosten
kumppanuuverkosto**

Partner Network of Rescue Departments

**Handbook for
FIRE SAFETY
in detached and
other small houses**



www.pelastustoimi.fi

A SMOKE ALARM IS A CHEAP LIFESAVER - only if it works!

According to the Rescue Act, every home must have a smoke alarm.

It is the duty of the occupant to buy a smoke alarm and maintain it in good working order.

Test the condition of your smoke alarm every month and replace the battery every year, for example on December 1st, the Fire Alarm Test Day.



TIP: By inserting a 10-year battery you need not worry about replacing it.

Acquisition and renewal of an electrically-connected smoke alarm is the responsibility of the owner, unless otherwise agreed.

A smoke alarm at the end of its useful life must be replaced even if a test with the test button shows that it works.

Replace your smoke alarm at least every ten years, unless the manufacturer has indicated a shorter replacement interval for the device. The useful life is counted from the time of manufacture (marked at the bottom of the device). The Rescue Department recommends that you write the useful life indicated by the manufacturer on the device. Follow the manufacturer's instructions.

Where should the smoke alarm be placed

Install the smoke alarm on the ceiling in the middle of the room, not closer than 50 cm to a wall, rafters or other obstructions to allow smoke reach the smoke alarm as freely as possible, as smoke and heat rise upwards. When you place the smoke alarm ensure that the sound can be heard from everywhere in the house.

Do not install the smoke alarm in the vicinity of ventilation shafts. To avoid false alarms do not install the smoke alarm in the vicinity of a stove, cooker, oven, toaster, sauna, bathroom or fireplace. Also dust gathered on the smoke alarm often cause false alarms. Follow the installation and maintenance instructions!

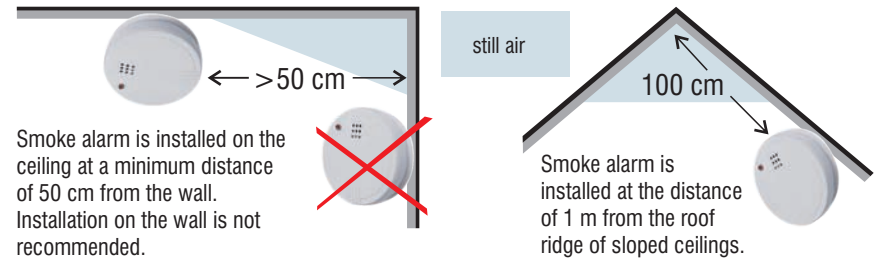

Smoke alarm is installed on the ceiling at a minimum distance of 50 cm from the wall. Installation on the wall is not recommended.

Smoke alarm is installed at the distance of 1 m from the roof ridge of sloped ceilings.

How many smoke alarms are needed?

A good principle is to install a smoke alarm in every bedroom and in routes leading outdoors.

A house must have at least one smoke alarm for each 60 m² on each floor including connected cellars and attics.

Smoke alarm is mandatory also in leisure houses and spaces that are not heated, such as storehouses, when they are used as accommodation. It is recommended that houses with fireplace should be equipped with both smoke alarm and carbon monoxide alarm.

The most important function of a smoke alarm is to alert occupants of incipient fire

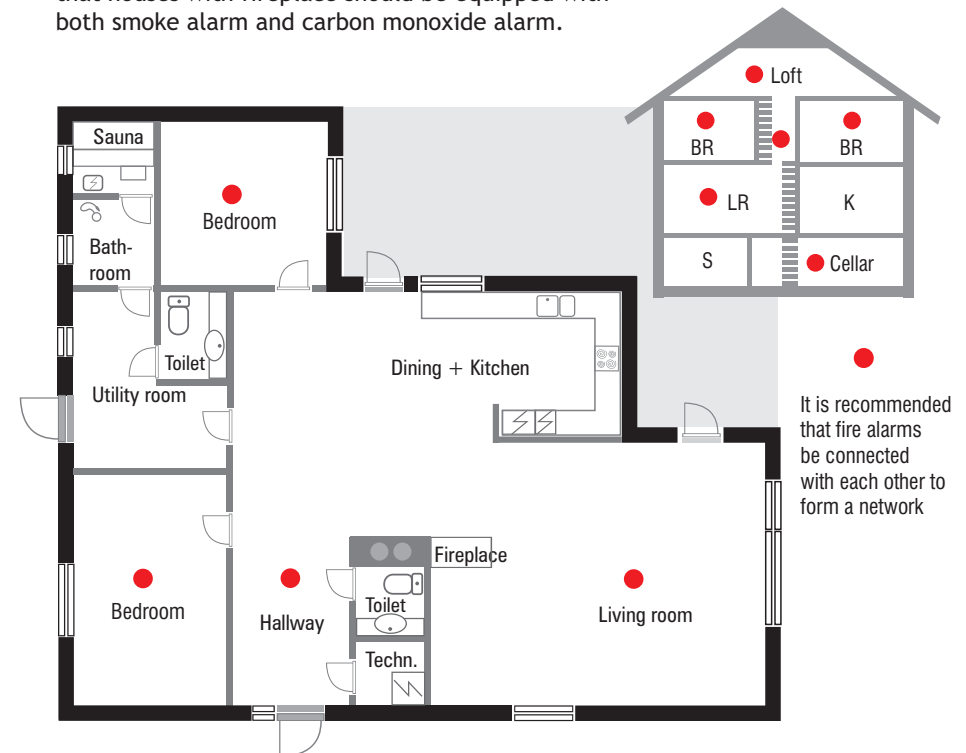

It is recommended that fire alarms be connected with each other to form a network

MINIMIZE RISKS AND LIVE IN SAFETY

Use electrical equipment safely according to instructions.

Most fires are caused by human error. Poor maintenance, incorrect use and forgetting to switch off an appliance are the leading causes of accidents.

TIP: There is a range of safety equipment, for example timers, available for electrical appliances.



Read the instructions for use of appliances before installation and use. Follow the instructions and save them for future use. Locate the appliances correctly. Make sure there is sufficient space for air circulation and do not block ventilation shafts. Find out the location of the main electrical switch and the main water shutoff valve of your home.

Stoves and ovens

- Do not leave oven or cooker on unsupervised.
- Always turn off the oven after use.
- Make sure there is no inflammable material on or close to the stove.
- Stove can be equipped with a timer or a stove guard from the rear of the appliance!
- Clean aspirator regularly.

Refrigeration equipment

- Ensure sufficient airflow around refrigerator and freezer.
- Do not place the appliance next to stove or other heat source or in direct sunlight.

Vacuum clean dust regularly from the rear of the appliance!

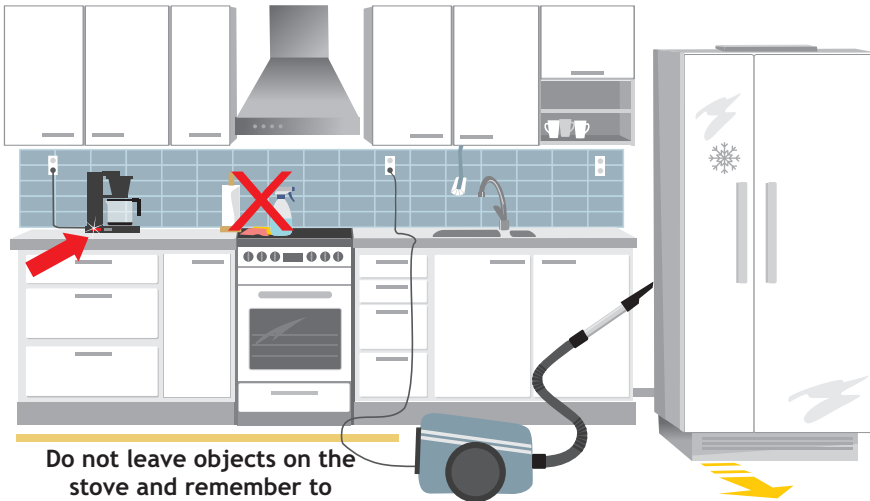

Do not leave objects on the stove and remember to switch off the coffeemaker!

Washing machines and dishwashers

- Do not leave the washing machine on unattended. This way you minimize fire and water hazards.
- Clear the flint filter regularly.
- Protect the appliance from water splashes.
- Close the water tap after use.



Do not leave electrical appliances on unattended

Central vacuum

- Install the appliance in a place where it is easy to maintain and protect from fire.
- Empty the dust from your central vacuum regularly.
- Clean and maintain the appliance in good order and replace filters regularly.

Lighting

- Follow user and installation instructions of light fixtures. Observe proximity to flammable materials, such as curtains.
- Replace burned-out or flashing fluorescent lights immediately.
- Never replace with a bulb having higher wattage than recommended.
- Keep lamps clear of dust.
- Make sure wall-mounted light fixtures are installed firmly to prevent them falling, for example, on the bed of couch.

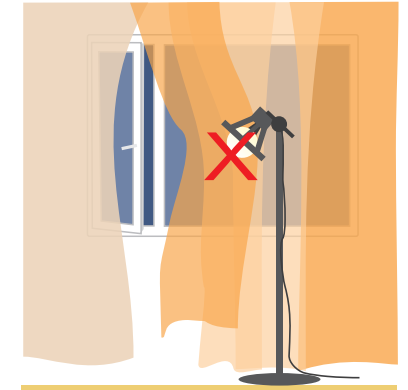

A hot lamp may ignite flammable material!

TIP: Minimize the risk by replacing with led lights!

TV set

- Ensure sufficient ventilation around the TV set. Do not cover ventilation slots.
- Vacuum clean around the openings and slots of the TV set regularly.

Charging electronic devices

- Do not leave the device unsupervised during charging sessions. Pay attention to abnormal overheating of the device and the charger.
- Use only chargers approved by the device manufacturer.
- Unplug the charger after charging session.
- Stop using faulty devices immediately.



Do not charge your phone on the bed!

Electric heaters

- Ensure the heater is located where it cannot be knocked over.
- Do not place the heater too close to curtains, furniture or anything flammable.
- Do not dry laundry on top of the heater or cover it with anything.
- Ensure nothing will fall on or be knocked over the heater.
- Prefer heaters with low surface temperature.

Remember to exercise due care and keep protective distances for iron, grill, electric heaters and other hot appliances.

Please note

- A faulty appliance must be replaced or its use stopped.
- Ensure sufficient airflow around all electronic appliances.
- Preferably plug your appliances to a wall outlet rather than extension cord.
- Only appliances with low wattage may be plugged to an extension cord with multiple outlets.
- Never plug an extension cord to another extension cord!
- Always call a certified electrician to do electrical installations and to check worn-out or suspicious installations.
- Ensure adequate insurance cover.

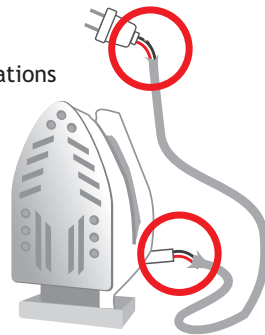

If an appliance or extension cord is for indoor use only, do not use outdoors!

Sauna

- Do not dry laundry or other flammable material above the sauna stove or near it.
- Check that there are no flammable items near the stove before switching the sauna stove on.
- The stove must be installed according to the manufacturer's instructions.
- Do not use sauna as a storage.
- Have broken or malfunctioning resistors and switches repaired.



Do not dry laundry in sauna!

PREDICT AND PREVENT

Accidents

Approximately one million accidents leading to injury occur every year, two thirds of which in home or during leisure, leading to death of about 2.700 Finns annually.

Most of the accidents in home or during leisure can easily be prevented with minor precautionary measures, elimination of risk factors and change of daily habits.

Falling, slipping, sharp object injuries and burns are the most common accidents in home.

Emergency supplies kit

Every household should prepare an emergency supplies kit for sudden situations. Make sure you have enough food, medicines and other necessities at home for at least three days.

In case of **disruption to the water supply** reserve backup drinking water and refillable water containers. When water supply is disrupted, close taps and regulate the use of water.

In case of **disruption to the electricity supply**, reserve torches, battery-operated radio, spare batteries, candles and matches. Unplug kitchen appliances and electrical devices during the power cut. Avoid opening freezer and refrigerator.

Home medicine cabinet

Choose a lockable medicine cabinet for your home. Keep medicines out of children's reach. Do not mount medicine cabinet in humid places such as bathrooms.

Ensure that prescription medicine packages show the name of the patient and purpose of use. **Return** expired medicines to pharmacy.

Display the **emergency number 112** and the number of **Poison Information Centre 0800 147 111** on the medicine cabinet.



Visit www.kotitapaturma.fi for further information about accident prevention.

Examples of further necessities to be included in the emergency supplies kit:

- toiletries
- spare power source
- cash money

Further information about preparedness at home at www.72tuntia.fi



FIRST AID FIREFIGHTING EQUIPMENT

First aid firefighting equipment include fire blankets and portable fire extinguishers. They are best suited for extinguishing small fires or fires in their initial stage.

Put out a grease fire for example with a lid of a pot. Turn off the aspirator.

Do not use water to extinguish a grease fire!

Turn off the heat source first by unplugging it or by turning off the main switch of the house, if that is possible.

Fire blanket

Fire blanket is used to extinguish a fire. Minimum size of a fire blanket is 120x180 cm. It is a handy way to put out a small grease fire, for example, in a stove top pan, or in a household appliance.

Install fire blanket on the wall where it is always ready for use. A good place for a fire blanket is the kitchen.



Portable fire extinguisher

Portable fire extinguisher is effective in putting out all incipient stage fires in your home. Ask a professional sales person to recommend a portable extinguisher best suited for your home (recommended efficiency rating at least 34A183B). A good place for a portable fire extinguisher is the hallway.

Have your extinguisher checked at regular intervals.

Have your extinguishers checked every two years.

Read the clear instructions for use on the extinguisher.

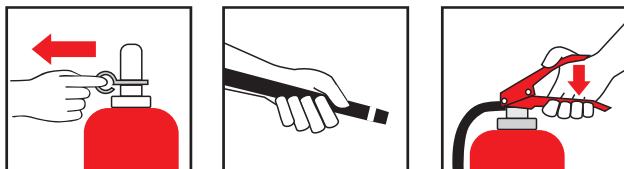

Acquire appropriate fire extinguishing equipment and learn how to use them



EMERGENCY ESCAPE - QUICKLY

- but safely

Each floor must have two escape routes. Besides the doors that are used normally, balconies and windows may function as escape routes.

If the distance from the bottom edge of a balcony or a window to the ground, or other safe landing surface used as escape route, exceeds 3.5 m, a fixed fire escape ladder has to be installed on the wall. Step spacing and width as specified on page 10.

Window used as an escape route must have a fixed opening handle.

The minimum width of the unobstructed opening area is 50 cm and the minimum height 60 cm, with the sum of width and height at least 150 cm.

Safe escape from a window is made easier with an extra handle bar installed on one side of the window, additional ladder steps or extension of the side rail of the ladder.

Determine two independent escape routes from bedrooms.

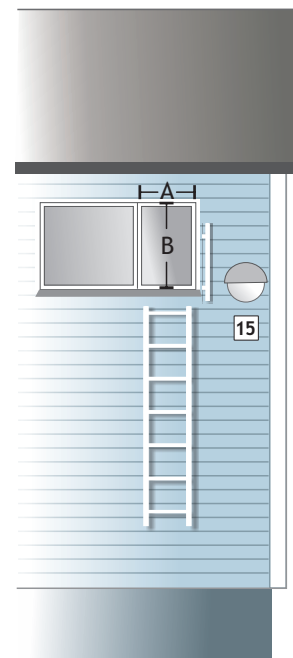

Escape window

minimum measurements of unobstructed opening area

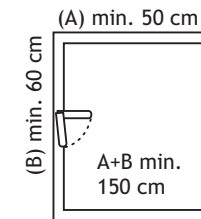

Escape windows must always be equipped with fixed handles!

Fixed escape ladder

Images with measurements on page 10

All escape routes must always be available for use without the use of a key!

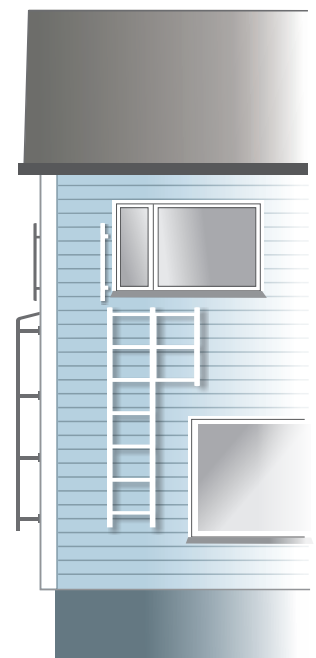

SAFETY ON THE ROOF

Access to maintenance targets on the roof must always be safe

Roof ladders and roof bridges

According to the Rescue Act, ladders, all parts of roof walkways and roof safety equipment must be kept in good order to allow safe chimney sweeping. On a roof with a roof slope over 1:8, a roof walkway, roof ladder, roof steps, roof platforms or foot supports are mandatory. A house higher than 9 m must have an anchoring point for lifelines.

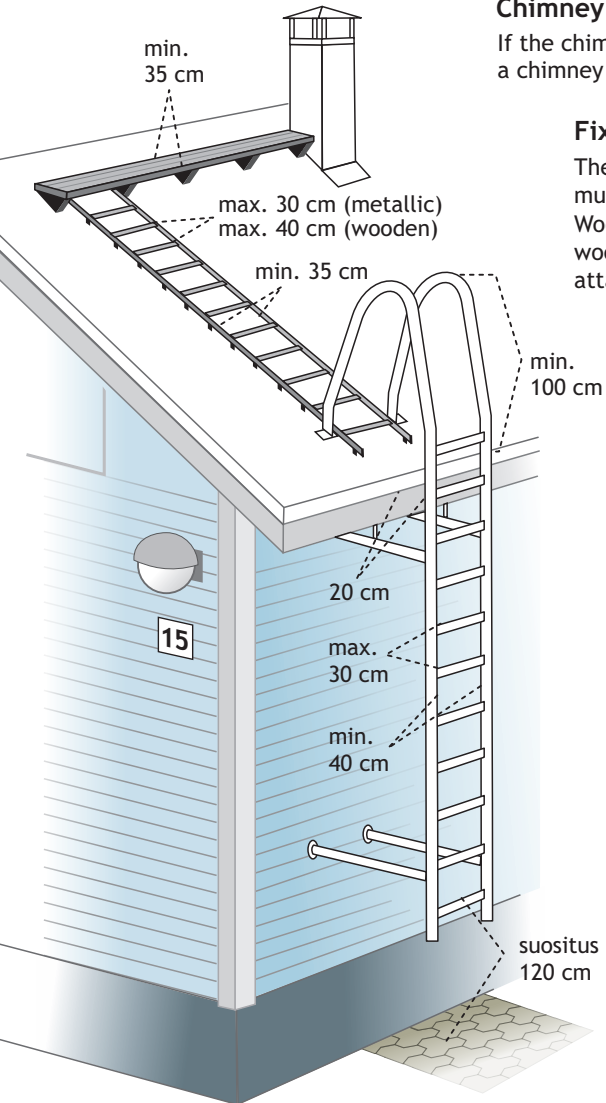

Chimney ladder

If the chimney rises over 120 cm from the rooftop, a chimney ladder and guardrail are mandatory.

Fixed wall ladder

The upper end of a load carrying ladder must be solidly secured to the roof. Wooden ladder must be manufactured using wood protected from decay. Rungs must be attached 10 mm into the side rail.

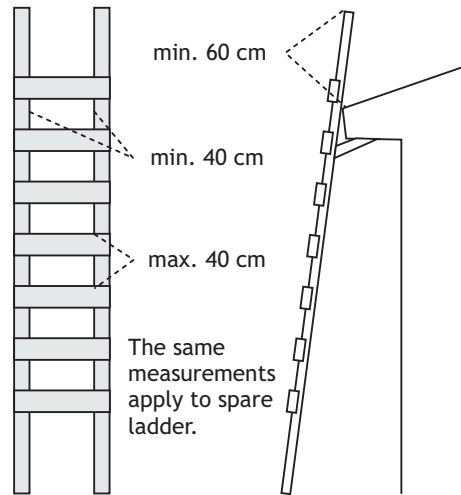

Prevent children from climbing with the bottom rung high enough from the ground, or with a suspended ladder part

FIREPLACES AND SMOKE FLUES

Fireplaces and smoke flues must be kept in such an order that they can be used safely.

Optimal burning of wood requires high temperatures. To achieve this both the room space and the firebox require sufficient combustion air. A significant number of damages to fireplaces and flues and consequent fires are caused by mistakes in the use of fireplaces.

The most frequent service to a fireplace is the removal of ashes. Too much ashes can, for example, distort the grate by preventing combustion air from cooling it. Ashes must be removed and stored so as not to cause a fire hazard. Metallic ash bucket with lid is recommended.

Floor protection of a fireplace with door

The floor protection for flammable materials must be at least 40 cm in front of the stove door and 10 cm on both sides measured from the side of the door.

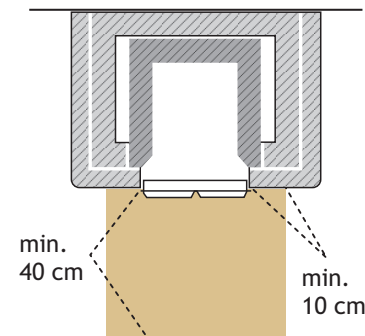

Floor protection of an open fireplace

An open fireplace over 75 cm deep or with an anti-roll lip 5 cm high requires a protective floor pad measuring at least 60 cm in front of the opening and 15 cm on both sides from the side of the opening.

When an open fireplace is over 75 cm deep and there is no anti-roll lip, a protective floor pad must be min. 75 cm forward and 15 cm measuring at the sides of the fireplace opening.



Fireplaces and smoke flues that are in use must be swept every year!

A fireplace and flue unused for three years must be swept before being used!

Chimney sweeping

Regular sweeping ensures efficient heating, optimum draft in the flue and prevents soot fires. The chimney sweep also controls the condition of the fireplace, flue and chimney helping avoid fires starting from a crack in the flue or fireplace. A chimney cap reduces damage caused by weather.

The owner or occupant of a house is responsible for regular chimney sweeping. The fireplaces and flues of a detached or other small house must be swept at least once a year.

A chimney sweep must be a qualified professional. He or she must give the customer a sweeping certificate after completing the job. The sweeping certificate should be saved.

Finland shifted to contract-based chimney sweeping. Rescue departments are no longer obligated to arrange chimney sweeping services.

Contact information is available on the internet, for example at www.nuohoojat.fi

STORAGE OF FLAMMABLE LIQUIDS AND GASES

Space	Flammable liquids and aerosols such as petrol, spray paint, oil, diesel oil	Liquefied petroleum gas (LPG)
Apartment	total 25 litres	25 kg
Attic or cellar	No	No
Separate storage space	total 50 litres	50 kg

It is forbidden to store liquefied petroleum gas (LPG) and other gases heavier than air in cellar and attic and other similar spaces of a building.

- Place gas cylinders as close to the front door as possible, and indicate their location with a sign on the front door. Markings and signs are helpful in rescue operations.
- Ensure sufficient ventilation, for example location of vents near the floor and the ceiling.
- A flammable liquid storage container must have a tight lid.
- Control the pressure regulator and the hose every year, and a liquid gas hose at least every 5 years.
- Regular inspection of an underground oil tank located in ground water area is mandatory. The first inspection is 10 years from the time it was put to use. Consecutive inspection intervals are determined by the condition class of the tank. A list of approved inspection companies is available at www.tukes.fi. Please note city-specific environmental protection regulations.



Do not store
liquefied
petroleum gas
in attic or cellar

WASTE CONTAINERS

It is forbidden to store any easily flammable material, such as waste containers, stacks of cardboard, pallets or firewood under buildings or in their immediate vicinity!

Minimize fire hazard of waste containers and shelters by placing them correctly. Safety distances between waste containers and eaves of the building are:

4 metres single waste containers

6 metres group of several waste containers and trolleys with pasteboard packages

8 metres waste shelters and skips with combustible material

If the distance is shorter, the containers or the waste shelter must be equipped with fire separating building elements.

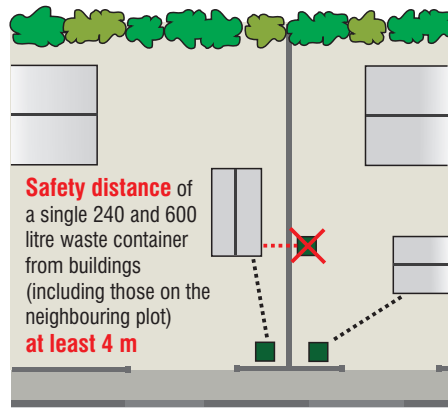

Safety distance of a single 240 and 600 litre waste container from buildings (including those on the neighbouring plot) **at least 4 m**

HOUSE NUMBER

The owner of the house is responsible for ensuring that the house number is visible to the street or other traffic routes. The number must be visible also in the dark and in all seasons. The house number guides, among others, emergency and service vehicles to the property.



Height of numbers 10 - 15 cm

GARAGES

A garage is intended for retention of motor vehicles only.

Items that can be stored in a garage comprise vehicles such as a car, motorbike, moped, scooter and an all-terrain vehicle, their tires, outboard motor, lawnmower, spare parts and tools needed for maintenance, as well as products related to outdoor sports.

Fuels in a garage

You are allowed to store the following amounts of most common flammable liquids and gases in the garage:

PETROL	DIESEL	LIQUEFIED PETROLEUM GAS (LPG)
60 L	200 L	25 KG

These amounts do not include petrol in the vehicle's tank.

Storage of liquid gas in a garage with the floor below the ground level is forbidden.

BOILER ROOM AND FUEL STORAGE

A boiler room and fuel storage are set up as their own fire compartment.

The fire-rated door of the boiler room must be self-closing and latching for fire safety. Boiler room ducts must be insulated with inflammable material. A door in an external wall does not need to be a fire door, a thermally insulated front door may be regarded as sufficiently safe.

New oil heating equipment and those with a significant structural modification must be inspected by the rescue authorities.

Note! The feed pipe of an inactivated oil tank must be capped or removed.

SELF-EVALUATION OF FIRE SAFETY

Rescue departments carry out their fire safety inspection duty, among other things, by sending a self-assessment form to the occupant.

- The occupant carries out a fire safety inspection in the house according to instructions for fire safety inspection and returns the completed form to the rescue department.

- Based on the returned inspection form, the authorities will decide whether they should carry out a fire inspection in your property or whether you need some advice.

- In case the self-assessment form is completed and returned but it contains deficiencies or issues to be fixed, follow-up actions will be considered separately.

- Deficiencies marked on the self-assessment form are primarily fixed by provision of education and guidance.

- If you fail to complete and return the form despite exhortation and other measures, a fire inspection will be carried out.

- If you fail to respond to the self-assessment form you may have to pay for the fire safety inspection. Inspections based on completed and returned self-assessment forms are free of charge.



A fire inspection is carried out to protect the occupant - not for the authorities!

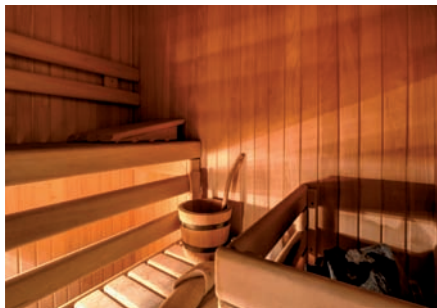

ACTION TO BE TAKEN WHEN YOU HEAR THE GENERAL ALARM SIGNAL

IF YOU ARE INDOORS



- 1 Close the doors and windows and turn the ventilation off.



- 2 Switch on the radio or TV and follow instructions.



- 3 Use your phone only if you are in need of immediate help.



- 4 If you smell gas, breathe through a damp cloth.



- 5 If possible, move to the highest floors of the building.

Do not leave the area unless told to do so by the authorities. Follow instructions and wait until the danger is over.

The general alarm signal is always accompanied by instructions to the public issued by the authorities. The instructions are communicated on all radio channels and shown as a running text on the upper part of the TV screen, and on text TV page 112. If required, vehicles with megaphone are used.

IF YOU ARE OUTDOORS



- 1 Go indoors and follow instructions shown on the column to the left. If you cannot go indoors, check the wind direction and move crosswind under the gas cloud.



- 2 Move to a higher location, as it is safer there.



- 3 If you are exposed to a gas cloud, move slowly. Protect yourself by breathing through a damp cloth.

The GENERAL ALARM SIGNAL warns the public of danger.



The public is alerted by a regularly rising and falling general alarm signal lasting for one minute and **repeated several times in a real emergency.**

THE ALL-CLEAR SIGNAL

A single continuous sound lasting for **one minute.**

The general alarm signal equipment is tested nationwide on the first Monday of each month at 12 noon, excluding public holidays. The test signal is a continuous sound lasting for 7 seconds.

ACTION IN CASE OF FIRE

If a fire breaks out, it is important to exit the building quickly and safely. Safe exit depends on your know-how and advance planning.

- **Put out** the fire, if you can do it safely.
- **Warn** others and evacuate those in danger.
- **Close** the doors and windows to prevent the fire from getting oxygen and the poisonous gas from spreading in the building.
- **Do not pick up** belongings from other rooms on your way out of the building.
- **Proceed** to the meeting place designated in advance.
- **Call** the emergency number 112 when you are in a safe place.

Evacuation from different rooms

- Make an advance escape plan showing the exit routes from different rooms in case of fire.
- Test how well the exit routes work and how easy they are to use.
- Escape windows must have fixed opening handles.



When you use the application for the first time you need to enter your phone number!

If the emergency number is momentarily busy - do not hang up!

Your call will be answered as soon as possible, and calls are always answered in the order they are received.

If the situation on the scene changes significantly after your emergency call, call the emergency response centre back to report it.

We recommend that you load the 112 Suomi application onto your phone. When you use the application to call the emergency response centre your location data is automatically transmitted to the emergency response centre and help will arrive more quickly. The application also includes general alarm notifications from the authorities.

Visit www.112.fi for further information on how to call the emergency number.

Further information is available at your local rescue department, website and social media.



www.pelastustoimi.fi

